

# BEKO



D 9420 NMK

en

Instruction Manual



## **en-Index**

**1-10**

---

|   |     |
|---|-----|
| Safety first .....                          | /1  |
| Transport instructions.....                 | /2  |
| Disposal .....                              | /2  |
| Device Setup .....                          | /2  |
| Get to know your device.....                | /3  |
| How to use the accessories .....            | /3  |
| Prior to startup.....                       | /4  |
| Setting the operating temperature.....      | /4  |
| Cooling .....                               | /5  |
| Defrosting of the device (Fresh Food).....  | /5  |
| Freezing .....                              | /6  |
| Defrosting of the device (Frozen Food)..... | /6  |
| Replacing the interior light bulb .....     | /7  |
| Cleaning and care .....                     | /7  |
| Practical tips and notes .....              | /8  |
| Examples of use.....                        | /9  |
| Normal operating noises.....                | /9  |
| What, if.....                               | /10 |
| Reversing the doors.....                    | /10 |

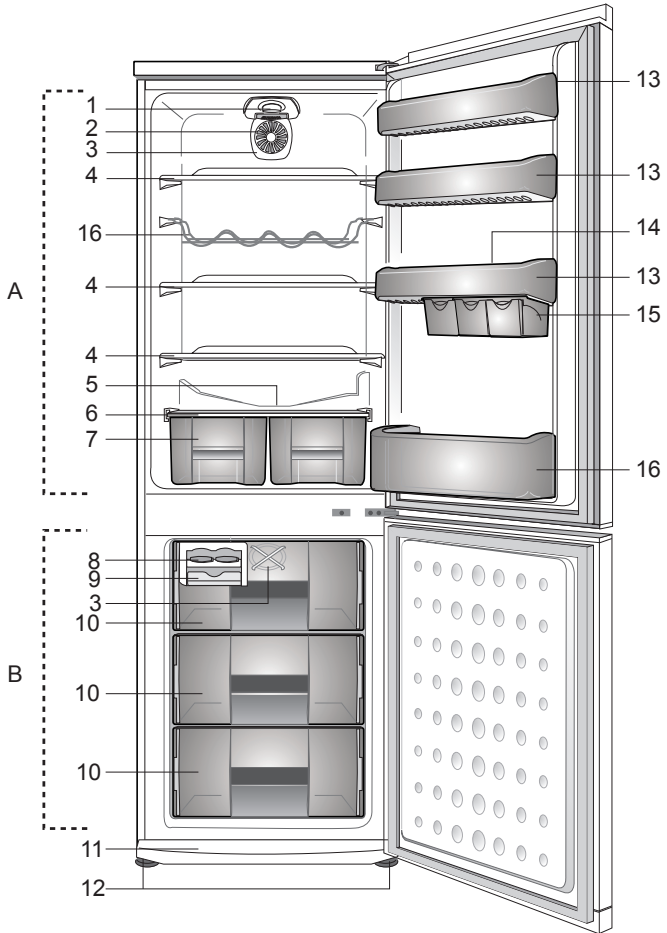

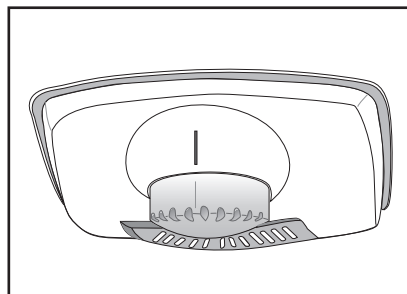

2

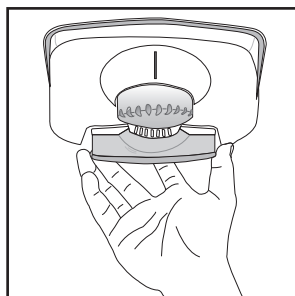
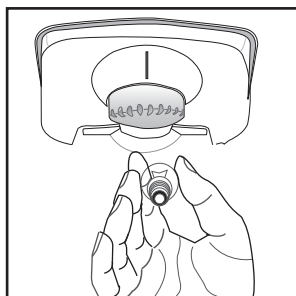
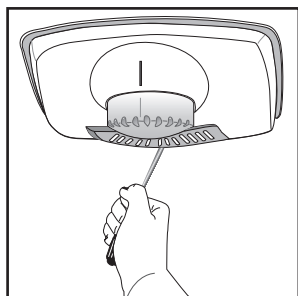

3

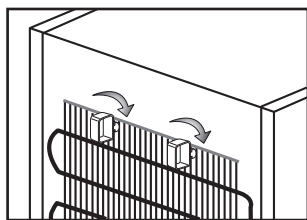

4

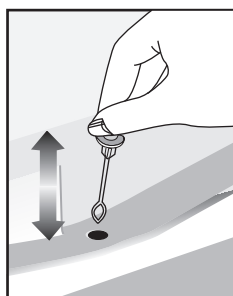

5

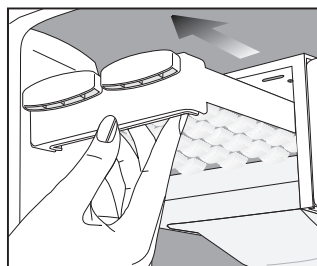

6

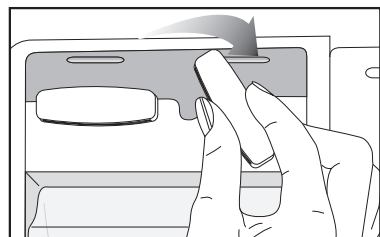

7

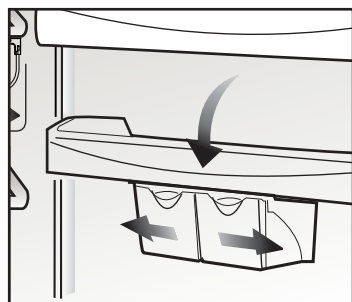

8

Congratulations on your choice of our product which will certainly provide you with many years of good service.

## Safety comes first!

Please read the operating manual carefully. It contains important information on the use of your device. If instructions are not adhered to, you may lose your right to service at no charge during the warranty period. Please keep this manual in a safe place and pass it on to later users if applicable.

- Do not connect your appliance to the electricity supply until all packing and transit protectors have been removed.
- Leave to stand for at least 4 hours before switching on to allow the system to settle if transported horizontally.
- This appliance must only be used for its intended purpose, i.e. the storing and freezing of edible foodstuff.
- We do not recommend use of this appliance in an unheated, cold room e.g. garage, conservatory, annex, shed, out-house, etc., see 'Location'.
- On delivery, check to make sure that the product is not damaged and that all the parts and accessories are in perfect condition.
- Do not operate a damaged device; if in doubt, check with the suppliers.
- Do not allow children to play with the device.
- Do not sit or stand on, or sit or stand children on, the device or the pull-out parts.
- Do not hang on the device door.
- Do not dispose of the appliance on a fire. Your appliance contains non CFC substances in the insulation which are flammable.
- Please contact your local authority for information on disposal and facilities available.

△ **Warning** - Keep ventilation openings, in the appliance enclosure or in the built-in structure, clear of obstruction.

△ **Warning** - Do not use mechanical devices or other means to accelerate the defrosting process, other than those recommended by the manufacturer.

△ **Warning** - Do not damage the refrigerant circuit.

△ **Warning** - Do not use electrical appliances inside the food storage compartments of the appliance, unless they are of the type recommended by the manufacturer.

- Avoid touching the metallic condenser wiring on the backside of the device; there is risk of injury.
- In the event of a possible malfunction, disconnect the device from the power mains first.
- Prior to cleaning the device, always unplug the power supply or shut off the fuse. Do not pull from the cable - pull from the plug.
- Repairs to the electrical equipment may only be made by qualified experts. If the connection cable is damaged, the manufacturer or customer service must replace it in order to avoid danger.

## Transport instructions

The device should be transported only in upright position.

The packing as supplied must be intact during transportation.

After a transport in the horizontal position, the device may only be taken into operation 4 hours after being stood up vertically again.

The appliance must be protected against rain, moisture and other atmospheric influences. The manufacturer assumes no liability if safety instructions are disregarded.

## Disposal

Make the device unusable immediately. Pull out the mains plug and cut the power cable. Remove or destroy snap or latch locks before disposing of the device. In this manner you prevent children from locking themselves in and endangering their lives.

## Device setup

- Do not operate your appliance in a room where the temperature is likely to fall below 10 °C at night and/or especially in winter. At lower temperatures the appliance may not operate, resulting in a reduction in the storage life of the food.

- The climate class rate of your appliance is given in Technical Features leaflet and written on the rating label inside the appliance. It specifies the appropriate operating ambient temperatures as explained below.

### Climatic class    Ambient temperatures

|             |                 |
|-------------|-----------------|
| SN.....     | +10 °C to 32 °C |
| N .....     | +16 °C to 32 °C |
| ST .....    | +18 °C to 38 °C |
| T.....      | +18 °C to 43 °C |
| SN-ST ..... | +10 °C to 38 °C |
| SN-T .....  | +10 °C to 43 °C |

## Location

Only place the device in dry rooms which can be aired.

Avoid direct sunlight or direct heat sources such as a stove or a heater.

If this cannot be avoided, the following minimum distances should be maintained:

Electric stoves: 3,00 cm

Heater: 3,00 cm

Cooling devices: 2,50 cm

- Ensure sufficient air circulation for your device.

- Make sure that sufficient room is provided around the appliance to ensure free air circulation.

Fit the two plastic wall spacers supplied with the appliance rotating 1/4 turn to the condenser at the back of the appliance (**Fig. 4**).

- The device should be located on a smooth surface. The two front feet can be adjusted as required. To ensure that your appliance is standing upright adjust the two front feet by turning clockwise or counter-clockwise, until the product is in firm contact with the floor. Correct adjustment of feet avoids excessive vibration and noise.

## Electrical connections

### Warning

This device must be grounded.

- Check whether the power type and voltage in the device location corresponds to the one stated on the rating label inside the device.

- The electrical safety of the device is only assured when the grounding system in the house is installed in accordance with regulations.

- When putting the device in, do not stand it on the power cable, otherwise the cable will be damaged.

- Ensure that the plug remains readily accessible. Do not use multiple adapter bar or extension cable.

## Get to know your device

### **Warning**

Below information about accessories are supplied just for reference. Below accessories may not be exactly same as the accessories of your appliance.

**Fig. 1**

- A)** Fridge compartment
  - B)** Freezer compartment
1. Interior light
  2. Thermostat knob
  3. Fan
  4. Adjustable shelves
  5. Defrost water collection channel - Drain tube
  6. Crisper cover
  7. Salad crisper
  8. Ice bank
  9. Ice box
  10. Freezer compartment
  11. Air grille
  12. Adjustable front feet
  13. Adjustable door shelves
  14. Egg tray
  15. Sliding storage boxes
  16. Bottle shelf
  17. Bottle holder

## How to use the accessories

### **Ice-matic (Fig. 6-7)**

Fill the ice-matics with water and put them in place. Your ice will be ready in about two hours. It is not necessary to take the ice-matic out in order to get ice; just turn it 90° to the right, and the ice will drop into the ice-bowl below. Then take out the ice-bowl to serve the ice. If you wish, you can leave the ice in the bowl for a while.

#### **Attention!**

The ice-bowl is only meant for collecting ice. If you put water in, it will break.

### **Sliding storage boxes (Fig. 8)**

This accessory is designed to use the door shelves' volume more efficiently. Moving those boxes right or left helps to easily settle high bottles to the shelf below.

### **Odor filter (Fig. 9)**

The odor filter inside the fan housing which is located on top of your fresh food compartment prevents formation of bad smell in your product.

To clean the odor filter, remove the fan housing and leave the filter under sun light for a day. Filter will be cleaned during this time period. Fit the filter back to its place. Perform this operation once a year.

## Prior to startup

Before you begin operating your device, the following points should be re-checked for safety:

- Is the device standing properly on the floor?
- Is there sufficient space for good air circulation?
- Is the interior clean? (Also see the section "Cleaning and care")
- Set the thermostat knob half way between 1 and 5 or Min. and Max.
- Now connect the device to the mains.

The compressor is turned on; the interior light comes on when the door is opened.

Do not place foodstuff into the refrigerator until the temperature has reached the desired level.

## Setting the operating temperature

(Fig. 2)

The operating temperature is regulated by the temperature control.

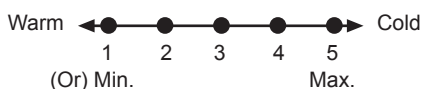

**1 = Lowest cooling setting** (Warmest setting)

**5 = Highest cooling setting** (Coldest setting)

(Or)

**Min. = Lowest cooling setting**

(Warmest setting)

**Max. = Highest cooling setting**

(Coldest setting)

The average temperature inside the fridge should be around +5°C.

Please choose the setting according to the desired temperature.

You can stop operation of your device by adjusting the thermostat knob to "0" position.

Please note that there will be different temperatures in the cooling area.

The coldest region is immediately above the vegetable compartment.

The interior temperature also depends on ambient temperature, the frequency with which the door is opened and the amount of foods kept inside.

Frequently opening the door causes the interior temperature to rise.

For this reason, it is recommended to close the door again as soon as possible after use.



## Cooling

### Food storage

The **fridge compartment** is for the short-term storage of fresh food and drinks.

Store milk products in the intended compartment in the refrigerator.

Bottles can be stored in the bottle holder or in the bottle shelf of the door.

Raw meat is best kept in a polyethylene bag in the compartment at the very bottom of the refrigerator.

Allow hot foods and beverages to cool to room temperature prior to placing them in the refrigerator.

#### **Attention**

Store concentrated alcohol only standing upright and tightly closed.

#### **Attention**

Do not store explosive substances or containers with flammable propellant gases (canned cream, spray cans etc.) in the device. There is a **danger of explosion**.

## Defrosting of the device

The fridge compartment defrosts automatically. The thawing water flows through the drain channel into a collection container at the rear of the device (**Fig. 5**).

During defrosting, water droplets form at the back of the fridge due to the evaporator. If not all of the drops run down, they may freeze again after defrosting remove them with a cloth soaked in warm water, but never with a hard or sharp object.

Check the flow of the thawed water from time to time. It may become plugged occasionally. Clean it with a q-tip or similar (see the section "Cleaning and care").

## Freezing

### Freezing food

The freezing area is marked with  this symbol.

You can use the device for freezing fresh food as well as for storing pre-frozen food. Please refer to the recommendations given on the packaging of your food.

#### Attention

Do not freeze fizzy drinks, as the freezing liquid may burst the bottle.

Be careful with frozen products such as coloured ice-cubes.

Do not exceed the freezing capacity of your appliance in 24 h. See Technical Features leaflet.

In order to maintain the quality of the food, the freezing must be effected as rapidly as possible. Thus, the freezing capacity will not be exceeded, and the temperature inside the freezer will not rise.

#### Attention

Keep the already deep-frozen food always separated with freshly placed food.

When deep-freezing hot food, the cooling compressor will work until the food is completely frozen. This can temporarily cause excessive cooling of the refrigeration compartment.

If you find the freezer door difficult to open just after you have closed it, don't worry. This is due to the pressure difference which will equalize and allow the door to open normally after a few minutes.

You will hear a vacuum sound just after closing the door. This is quite normal.

### Defrosting of the device

The freezer compartment defrosts automatically.

#### Warnings!

The fan inside the freezer compartment circulates cold air.

**Never insert any object through the guard. Do not allow children to play with the freezer fan.**

**Never store products that contain inflammable propellant gas (e.g. dispensers, spray cans etc.) or explosive substances.**

Don't cover the shelves with any protective materials, which may obstruct air circulation. Do not allow children to play with the appliance or tamper with the controls.

**Do not obstruct the freezer fan guard to ensure that you obtain the best possible performance from your appliance.**

## Replacing the interior light bulb (Fig. 3)

Should the light fail to work, proceed as follows.

### 1- Switch off at the socket outlet and pull out the mains plug.

You may find it useful to remove shelves for easy access.

2- Use a flat tipped screwdriver to remove the light diffuser cover.

3- First check that the bulb hasn't worked loose by ensuring it is screwed securely in the holder. Replace the plug and switch on.

If the bulb works, replace the light cover by inserting the rear lug and pushing up to locate the front two lugs.

4- If the light still fails to work, switch off at the socket outlet and pull out the mains plug.

Replace the bulb with a new 15 watt (max) screw cap (SES) bulb.

5- Carefully dispose of the burnt-out light bulb immediately.

Replacement light bulb can easily be obtained from a good local electrical or DIY store.

## Cleaning and care

### Interior and Exterior Surfaces

#### Attention

**Always unplug the power supply or shut off or remove the fuse before cleaning.**

Clean the exterior using lukewarm water and a mild detergent.

Never use detergents, abrasive or acidic agents.

Wipe the inside compartment dry.

Be careful to prevent water from getting into contact with the electrical connections of the temperature control or the interior light.

If the device is not going to be used for a long period of time, switch it off and remove all food. Clean the device and keep the door open.

To preserve the appearance of your device, you can polish the exterior and the door accessories with a silicone wax.

Clean the condenser at the back of the device once a year using a brush or a vacuum cleaner. Dust build-up leads to increased energy consumption.

Inspect the door gasket at regular intervals.

Clean with water only, and wipe totally dry.

### Cleaning of the accessories

#### Door shelves:

Remove all food from the door shelves.

Lift the cover of the shelf upwards and pull it off sideward.

Remove the bottom of the door shelf by pushing it upwards.

#### Collecting container (Pan):

Make sure that the pan at the back of the device is always clean.

Gently release the snap of the pan from the compressor by pushing it using a tool (like screwdriver), so that the pan can be removed.

Lift the pan, clean it and wipe it dry.

Re-assemble in reverse order.

#### Crisper or Drawers:

To clean a drawer, pull it out as far as possible, tilt it upwards and then pull it out completely.

## Practical tips and notes

### Cooling

- Clean fresh food and vegetables before storing in the crisper bin.
- Always pack or wrap food, or put it in a suitable container, before storing it in the appliance.
- Wrap food which is not suitable for storage at cold temperatures in polyethylene bags (pineapple, melons, cucumbers, tomatoes etc.).
- Food with strong odour or apt to acquire odour should be wrapped in airtight or smell-proof packaging material.
- Keep fresh food separate from cooked food, to avoid bacteria contamination.
- Never keep fresh meat in the fridge for more than 2 or 3 days.
- Remove any left-over canned food from the can and store it in a suitable container.
- Refer to the shelf life indicated on the food packaging.
- Do not obstruct the air circulation inside the device by covering the shelves.
- Never keep any dangerous or poisonous substances inside your device.
- Always check food that has been stored for a long period of time for its suitability for consumption.
- Do not store fresh and cooked food together in the same container.
- Close the door immediately after opening, to avoid unnecessary energy consumption.
- Do not use hard or sharp objects to remove the ice build-up.
- Do not load hot food into your device.

### Freezing

- Always leave food to thaw in a container that allows the thawing water to run off.
- Do not exceed the maximum allowable freezing capacity when freezing fresh food (see the section "Freezing")
- Do not give children ice-cream and water ices direct from the freezer.  
The low temperature may cause freezer burns on lips.
- Never re-freeze defrosted food; defrosted food must be consumed within 24 hours. Only food that has been cooked can be refrozen.
- Do not take out frozen food with wet hands.
- Store only fresh and impeccable food.
- Always use appropriate packaging material to avoid odour penetration or degradation of the food.
- Store commercially frozen food in accordance with the instructions given on the packaging.
- Freeze cooked food in small quantities. This ensures rapid freezing and maintains the quality of the food.
- Do not freeze liquid in tightly closed bottles or containers.  
The bottles/containers may burst at low temperatures.
- Carry pre-frozen food in suitable bags and place it in your freezer as soon as possible. Always defrost food in the fridge compartment.

## Examples of Use

|                                    |  |
|------------------------------------|--|
| White wine, beer and mineral water | chill before use   |
| Bananas                            | do not store in a fridge   |
| Fish or offal                      | store in polyethylene bags only  |
| Cheese                             | use airtight containers or polyethylene bags; for best results, take out from the fridge an hour before consumption. |
| Melons                             | store only for a short period of time, use airtight packaging/wrapping   |
| Raw meat and poultry               | do not store together with delicate food such as cooked food or milk   |

## Normal operating noises

**Various functional noises are completely normal due to the operation of the cooling system of your appliance;**

- Gurgling, hissing, boiling or bubbling noises are caused by the refrigerant, circulating inside the cooling system. These noises can still be heard for a short period of time after the compressor shuts off.
- Sudden, sharp cracking or popping noises are caused by the expansion and contraction of the inside walls or some components inside the cabinets.
- Buzzing, whirring, pulsating or high-pitched humming noises are caused by the compressor. These noises are slightly louder at the start-up of the compressor and reduce when the appliance reaches the operating temperatures.

**Also to avoid disturbing vibrations and noises make sure that;**

- Your refrigerator is standing level on all four feet.
- Your refrigerator is not in contact with the walls, surrounding objects or kitchen cabinets and furniture.
- Cans, bottles or dishes inside the refrigerator are not touching and rattling against each other.
- All shelves and bins are mounted correctly inside the refrigerator cabinets and doors.

## What, if....

### **1- The device will not work, even though it is switched on.**

- Check if the mains plug is properly connected!
- Check if the mains supply is in order, or if a fuse has been tripped!
- Check the temperature control for correct setting!

### **2- There is a power failure.**

Keep the doors of your device closed. Frozen food will not be affected if the power failure lasts less than the "Conservation Time From Failure" (hours) declaration mentioned in the Technical Features leaflet. If the power failure lasts longer, check the food and consume it immediately.

You can also cook the defrosted food and then re-freeze it.

### **3- The interior light does not work.**

Check the power supply!

Check the installation of the light bulb! Unplug the power supply before checking the light bulb. (Also see the section "Replacing the interior light")

### **4- Other possible malfunctions**

Not every malfunction is a case for our customer service. Very often, you can easily resolve the problem without requesting service. Before requesting service, please check if the malfunction has been caused by an operating error. If this is the case, and a service has been requested, a service charge will be levied even if the device is still under guarantee.

If the problem persists please contact your dealer or customer service.

Please have the type and serial number of your device when calling. The rating label is located inside.

## Reversing the doors

The door of your refrigerator is designed to operate towards both sides at your convenience. If you want the door to open towards the other side, please call the nearest authorized maintenance service for assistance. Tel.:444 1 404